

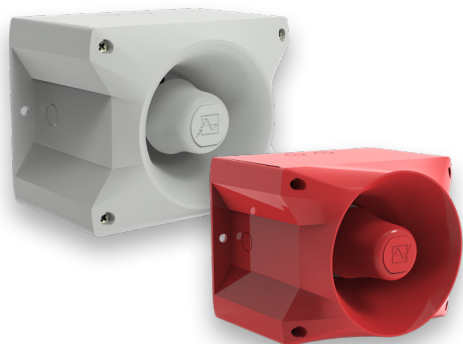









PATROL SOUNDERS 117/122 DB(A) PA 10 / PA 20



reddot design award
winner 2013

PATROL – the new generation of sounders.
Three dimensional innovation.









- Safe; an incorrect installation is virtually impossible.
- Easy; significantly shorter assembly and installation times.
- Economical; extremely high efficiency and good penetration of acoustical obstacles significantly reduce the required number of sounders.

									
protection system	impact-proof housing	operating temperature	acoustic penetration	external tone selection	24-48 V DC	24-48 V DC		warranty	

PRODUCT	PA 10			PA 20		
DATA						
Operating range	95–265 V	20–30 V	10–60 V	95–265 V	20–30 V	10–60 V
	AC 50 60		DC	AC 50 60		DC
Nominal current consumption ¹	20-115 mA	250-900 mA	60-485 mA	75-330 mA	500-1800 mA	120-880 mA
Sound pressure level	117 dB(A)			120 dB(A) 122 dB(A)		
Sound pressure level @DIN-tone	115 dB(A)			118 dB(A) 120 dB(A)		
Sound level reduction	max. –12 dB via potentiometer					
Alarm tones	80 / 4 tones are externally selectable					
Operating temperature	–40 °C ... +55 °C					
Storage temperature	–40 °C ... +70 °C					
Relative humidity	90 %					
Protection system according to EN 6052	IP 66					
Protection class	II					
Duty cycle	100 %					
Material	PC / ABS blend similar to RAL 3000 (flame red) RAL 7035 (light grey) RAL 9003 (signal white)					
Cable entry	5x M20 knock-outs on side, 1 knock-out on back					
Integrated seal with cable entry	6–13 mm (feed-through grommet)					
Connecting terminals	2.5 mm ² fine wire with cable end sleeve, AWG 16					
Weight	1,060 g		1,050 g	1,200 g		1,090 g

¹ Power consumption dependent on operating voltage.

OPTIONS/ACCESSORIES

							
---	---	---	---	---	---	---	---

DIMENSIONS

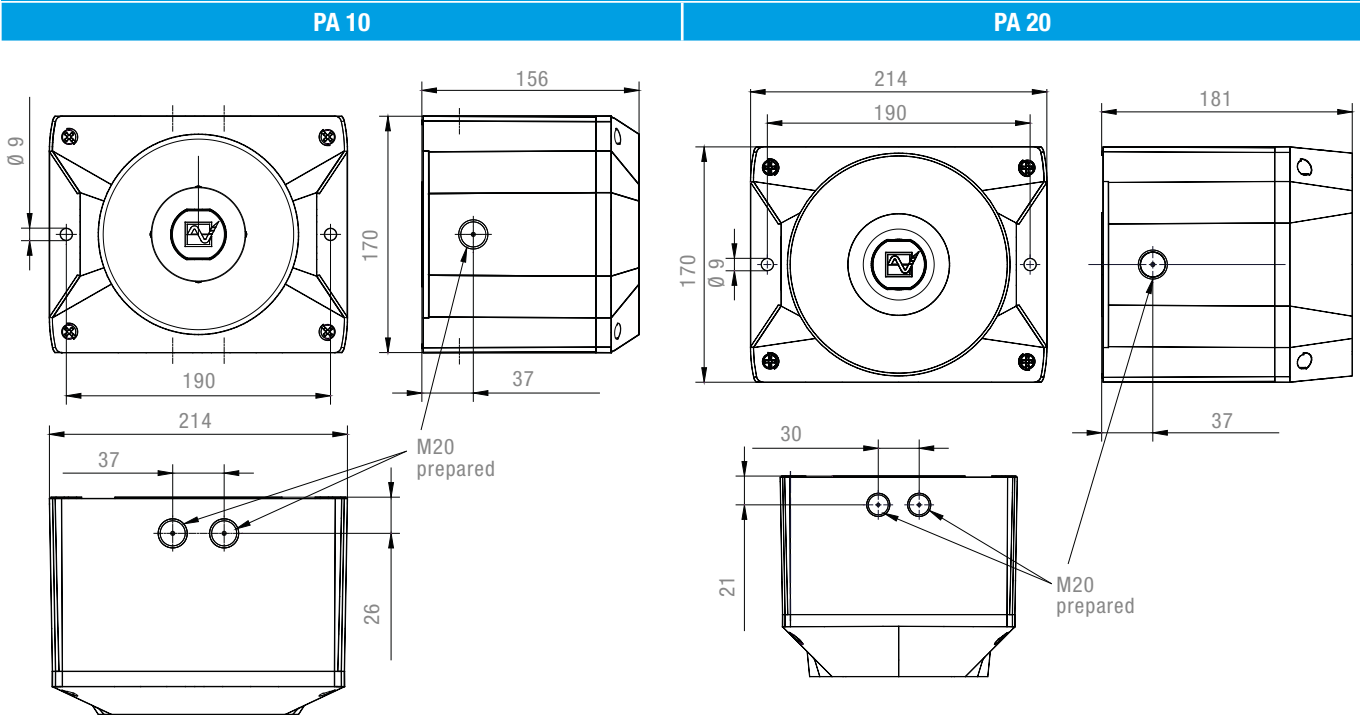

ARTICLE NO.		PA 10			PA 20		
VERSION	RATED VOLTAGE	95–265 V AC	24 V AC	10–60 V DC	95–265 V AC	24 V AC	10–60 V DC
Standard	housing red	23360640000	23360300000	23360630000	23370640000	23370300000	23370630000
GL/MED	housing red	23360640001	23360300001	23360630001	23370640001	23370300001	23370630001
Standard	housing grey	23360640055	23360300055	23360630055	23370640055	23370300055	23370630055
GL/MED	housing grey	23360640056	23360300056	23360630056	23370640056	23370300056	23370630056

Article numbers for other voltages and versions on request.

ARTICLE NO.		PA 10 PA 20
Enclosure fitting	For connection (daisy-chaining) of several sounders of the PATROL series.	28300000003
Surface gasket	Sealing of the sounder installation surface when, e. g. cable entry is executed from the back.	28300000006
Tamper-proof sealing (pack of 4)	Anti-tamper sealing for fasteners of the PATROL devices after installation in order to prevent manipulation of the devices.	28300000002
Panel mount installation kit PATROL	The PATROL devices are also suitable for panel mounting. This kit consists of a plug connector for the electrical contact, as well as all installation materials.	28300000009

TONE TABLE			
NO.	DESCRIPTION		
1	no tone		
2	Sawtooth, DIN tone 33404-3 Germany (emergency signal), PFEER PTAP	1200 Hz 500 Hz	
9	Slow whoop, fire alarm, UK BS5839-1	970 Hz 800 Hz	
11	Interrupted tone (fast)	970 Hz 800 Hz	
13	Interrupted tone	900 Hz 700 Hz	
15	Slow whoop, evacuation alarm Netherlands NEN 2575	1200 Hz 500 Hz	
16	Slow whoop, evacuation alarm Australia AS2220	1200 Hz 500 Hz	
18	Slow whoop, NFPA	775 Hz 422 Hz	
22	Pulsating tone, Australien alert AS1670, ISO8201	1200 Hz 500 Hz	
23	Siren	2400 Hz 500 Hz	
24	Siren	1200 Hz 300 Hz	
25	Siren	800 Hz 300 Hz	
26	Siren, industrial alarm Germany	1000 Hz 150 Hz	
27	Sweeping	2900 Hz 2400 Hz	
29	Sweeping (fast)	2900 Hz 2400 Hz	
30	Sweeping	2900 Hz 2400 Hz	
31	Sweeping, France NFC48-265	1600 Hz 1400 Hz	
33	Sweeping (medium), UK BS5839-1	1000 Hz 800 Hz	
34	Sweeping (fast)	1000 Hz 800 Hz	
35	Sweeping (fast), UK BS5839-1	1000 Hz 800 Hz	
36	Sweeping	1500 Hz 700 Hz	
43	Sweeping	1200 Hz 500 Hz	
44	Sweeping, IMO 3d, Germany KTA3901 evacuation alarm	1200 Hz 500 Hz	
45	Sweeping	1200 Hz 500 Hz	
46	Sweeping, general alarm Finland	1500 Hz 500 Hz	
52	Continuous tone	2400 Hz	
53	Continuous tone	2000 Hz	
54	Continuous tone, Finland (all-clear signal)	1500 Hz	
55	Continuous tone, PFEER gas alarm	1200 Hz	
56	Continuous tone	1000 Hz	
57	Continuous tone, UK BS5839-1	950 Hz	
59	Continuous tone	880 Hz	
60	Continuous tone	825 Hz	
61	Continuous tone	800 Hz	
63	Continuous tone	725 Hz	
65	Continuous tone, Sweden SS031711 (all-clear signal)	660 Hz	
66	Continuous tone	554 Hz	
67	Continuous tone, Germany KTA3901 (all-clear signal)	500 Hz	
68	Continuous tone	470 Hz	
69	Continuous tone	440 Hz	
71	Continuous tone	340 Hz	
77	Interrupted tone	2200 Hz	
82	Interrupted tone, PFEER (general alarm), UK BS5839-1 (back-up alarm)	1000 Hz	
83	Interrupted tone, PFEER (general alarm)	1000 Hz	
88	Interrupted tone	950 Hz	
90	Interrupted tone	825 Hz	
91	Interrupted tone	800 Hz	
92	Interrupted tone	800 Hz	
93	Interrupted tone (fast), Horn	800 Hz	
97	Interrupted tone	725 Hz	
98	Interrupted tone, Sweden SS031711 (emergency signal)	700 Hz	
100	Interrupted tone, industrial alarm Germany	680 Hz	
101	Interrupted tone, Sweden SS031711 (important message (pre-mess))	660 Hz	
102	Interrupted tone, Sweden SS031711 (local warning)	660 Hz	
103	Interrupted tone, Sweden SS031711 (air raid warning)	660 Hz	
104	Interrupted tone, Sweden SS031711 (emergency signal)	660 Hz	
107	Interrupted tone, Germany KTA3901 (evacuation alarm)	500 Hz	
109	Interrupted tone, Australia AS2220, AS1610, AS1670	420 Hz	
110	Interrupted tone, (fast variable), bell	1450 Hz	
111	Interrupted tone, ISO8201 (emergency evacuation signal), USA (evacuation alarm)	470 Hz	
112	Interrupted tone, ISO8201 (emergency evacuation signal)	950 Hz	
113	Interrupted tone, ISO8201 (emergency evacuation signal), sweeping	2850 Hz	

TONE TABLE				
NO.	DESCRIPTION	NO.	DESCRIPTION	
115	Interrupted tone, IMO (telephone call)		131	Alternating tone, UK BS5839-1 (fire alarm, railway crossing)
116	Interrupted tone, IMO (leave ship)		135	Alternating tone, UK BS5839-1 (fire alarm, increased urgency – railway crossing)
117	Interrupted tone, IMO SOLAS III/50 + SOLAS III/6.4 (general alarm)		142	Alternating tone
122	Alternating tone		143	Alternating tone, industrial alarm Germany
123	Alternating tone		144	Alternating tone
124	Alternating tone, Singapore		146	Alternating tone, France NFS 32-001 (fire alarm)
125	Alternating tone		147	Alternating tone, Sweden SS031711
128	Alternating tone		148	Alternating tone, Sweden SS031711
130	Alternating tone, UK BS5839-1 (fire alarm)		152	Alternating tone (two tone chime)

CONTROL OF THE TONES

DIP-SWITCH (SETTING OF BASIC TONE)								EXTERNAL TONE SELECTION			DIP-SWITCH (SETTING OF BASIC TONE)								EXTERNAL TONE SELECTION						
1	2	3	4	5	6	BASIC TONE	C1	C2	C1+C2	1	2	3	4	5	6	BASIC TONE	C1	C2	C1+C2						
TONE NO.										TONE NO.															
						1			2						ON	71			131			52			93
ON						2 *			128						ON	77			61			52			122
	ON					2			26						ON	82			131			52			83
ON	ON					2			61						ON	83			56			2			82
		ON				9			57						ON	88			2			57			128
ON		ON				15			131						ON	90			131			52			125
	ON	ON				16			109						ON	91			30			52			110
ON	ON	ON				18			111						ON	92			33			52			57
			ON			22			16						ON	93			2			128			57
ON			ON			23			131						ON	97			2			63			93
	ON		ON			24			131						ON	100			131			52			125
ON	ON		ON			25			131						ON	101			98			102			65
		ON	ON			26			2						ON	103			131			65			147
ON		ON	ON			27			123						ON	104			103			65			101
	ON	ON				29			35						ON	109			16			52			22
ON	ON	ON				30			27						ON	110			131			61			91
				ON		31			131						ON	112			2			57			128
ON				ON		33			30						ON	113			52			123			104
	ON			ON		34			35						ON	115			117			116			44
ON	ON			ON		35			27						ON	116			117			93			125
		ON		ON		36			146						ON	117			93			116			125
ON		ON		ON		43			131						ON	123			27			52			77
	ON	ON		ON		45			2						ON	124			53			83			2
ON	ON	ON		ON		52			15						ON	130			2			107			67
			ON	ON		54			46						ON	131			2			112			57
ON			ON	ON		55			131						ON	135			16			56			109
	ON		ON	ON		56			82						ON	142			2			54			88
ON	ON		ON	ON		59			143						ON	143			59			93			33
			ON	ON		60			131						ON	144			110			61			2
ON		ON	ON	ON		65			131						ON	146			31			67			57
	ON	ON	ON	ON		66			110						ON	148			131			52			92
ON	ON	ON	ON	ON		69			131						ON	152			110			61			13

* factory setting

CONNECTION DIAGRAM

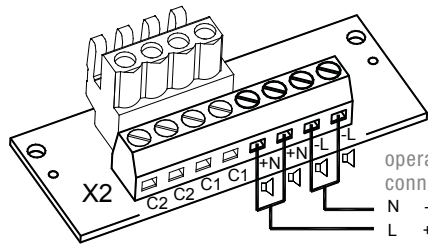

electrical connection and tone selection through external control of C1 and C2

operating voltage connection
 AC: L N -
 DC: + -

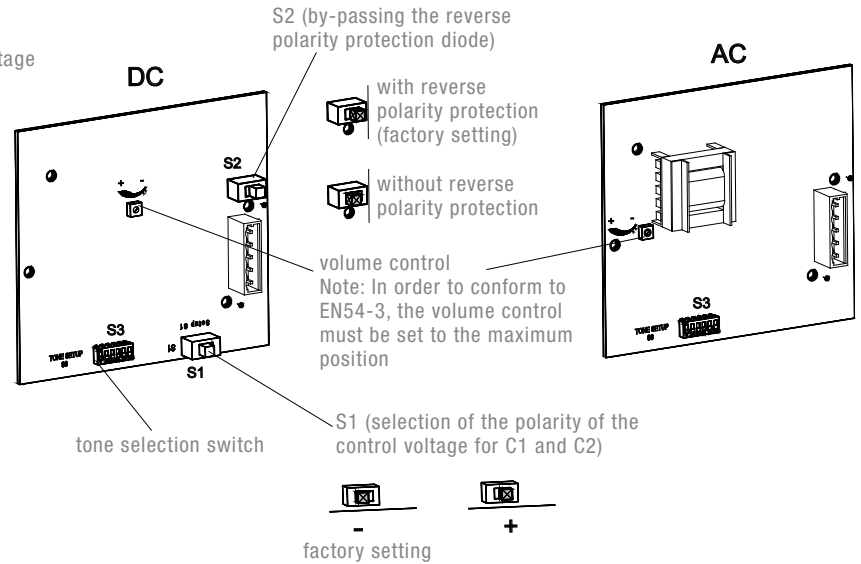

CONFORMITY TO STANDARDS

The acoustic parameters conform to the European standard DIN EN ISO 7731: "Ergonomic – alarms for public areas and workplaces – acoustic alarms".

The requirement for an acoustic alarm signal can be found in the harmonised standards:

- EN 60204-1 Electrical equipment of machines
- EN 60825-1 Radiation safety of laser devices, identical to IEC 825 and DIN-VDE 0837